

Metallo 100

MET-100-N-PC
MET-100-1TH-PC
MET-100-3TH-PC



Polished Chrome washstand topped with a Lario 100 Solo basin

- Option to order with or without faucet/tap holes
- Two legs with distinctive tee joint detailing
- Towel rail and rack for storage
- Wall anchors included

Waschbeckenständer in poliertem Chrom, mit dem Becken Lario 100 Solo

- Mit oder ohne Armaturenlöcher erhältlich
- Zwei Beine mit charakteristischen Gelenken
- Handtuchhalter und Aufbewahrungsregal
- Inklusive Wandbefestigung

Lavabo chromé surmonté d'une vasque Lario 100 Solo

- Possibilité de commander avec ou sans trou de robinetterie
- Deux pieds avec finition des jointures en T
- Porte-serviette et support pour le rangement
- Elements d'ancrage mural inclus

Palanganero en acabado cromado pulido con lavamanos Lario 100 Solo

- Con posibilidad de solicitarlo con o sin orificios para la grifería
- Incluye dos patas con los clásicos detalles en las uniones
- Soporte toallero y balda para almacenaje
- Incluye los anclajes de pared

Lavabo in cromo lucido sormontato da un lavabo Lario 100 Solo

- Opzione per ordinare con o senza rubinetto/fori per rubinetto
- Due gambe con dettagli di giunture eleganti
- Portasciugamani e un ripiano
- Ancoraggi a muro inclusi

Metallo 100

MET-100-N-PC / MET-100-1TH-PC / MET-100-3TH-PC

Special Options/Sonderoptionen/Options spéciales/Opciones especiales/Opzioni speciali



Tap Holes

Bohrungen für Armaturen / Trou de robinetterie /
Agujeros para grifos / Fori per rubinetti

Option to order with or without pre-drilled tap holes
Mit oder ohne Vorbohrungen für Armaturen erhältlich
Option de commande : avec ou sans trou de robinetterie
Disponibile con o sin agujeros pretaladrados para grifos
Possibilità di ordinare con o senza fori per rubinetti



MET-100-N-PC

No tap holes
Ohne Bohrungen für Armaturen
Sans trou de robinetterie
Sin agujeros para grifos
Senza fori per rubinetti



MET-100-1TH-PC

1 pre-drilled tap hole
Mit 1 Vorbohrung für Armaturen
1 Trou de robinetterie pré-percé
Con 1 agujero pretaladrado para grifos
1 foro per rubinetti preforato



MET-100-3TH-PC

3 pre-drilled tap holes
Mit 3 Vorbohrungen für Armaturen
3 trous de robinetterie pré-percés
Con 3 agujeros pretaladrados para grifos
3 fori per rubinetti preforati

Recommended: K24/K25



Internal overflow
Internem Überlauf
Trop-plein interne
Rebosadero integrado
Troppieno interno



K24



K25



Metallo 100

MET-100-N-PC / MET-100-1TH-PC / MET-100-3TH-PC

Front View

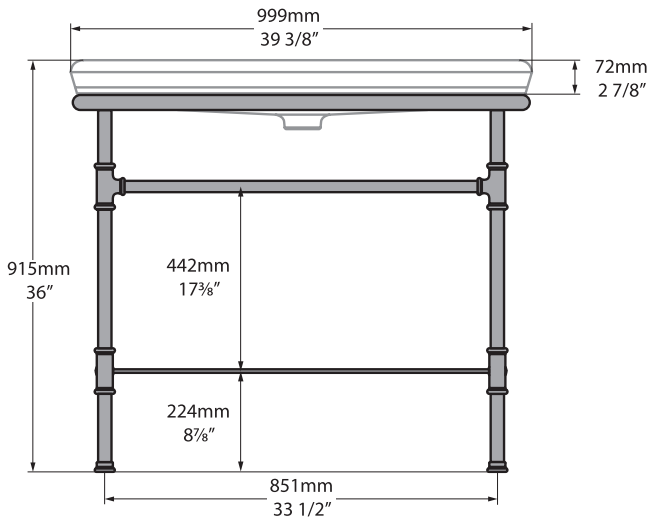

Side view

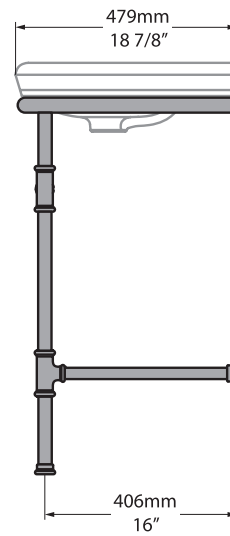

MET-100-N-PC
MET-100-1TH-PC
MET-100-3TH-PC

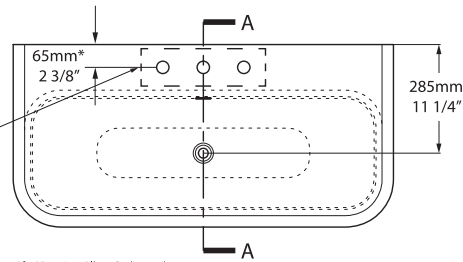
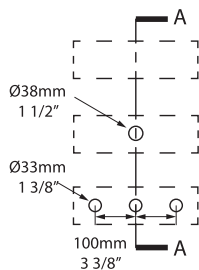

*for Victoria + Albert Baths products, check if fitting other products



Tap holes can be drilled by installer
Armaturenlöcher können leicht vom Installateur gebohrt werden
Les trous de robinetterie peuvent être percés par l'installateur
Pueden ser perforados por el instalador
I fori per rubinetti possono essere perforati dall'installatore

Section AA

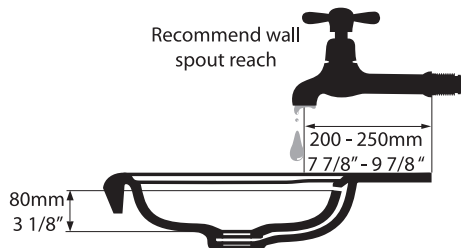

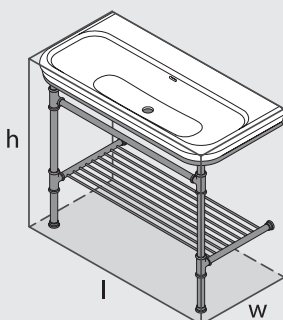

*All measurements subject to +/-5% tolerance

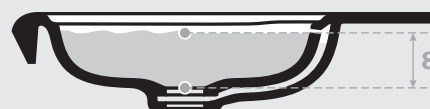

l = 999mm / 39³/₈"
w = 479mm / 18⁷/₈"
h = 915mm / 36"



 48
 33

 15ltr
 0ltr



.dwg | .dxf | .skp www.vandabaths.com



Massachusetts Code: Approved
cUPC listing by IAPMO: File No. 6970



VA/1204/02/Jan19