

DRAFT COPY

DO NOT SCALE. IF IN DOUBT ASK!

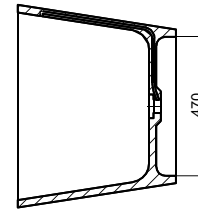

SECTION B-B

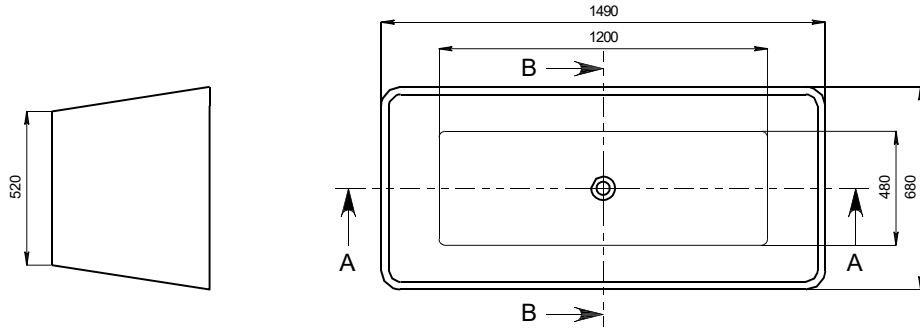
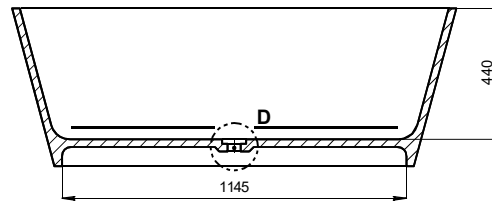
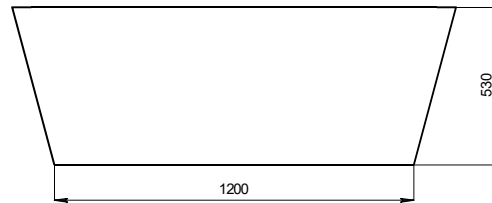
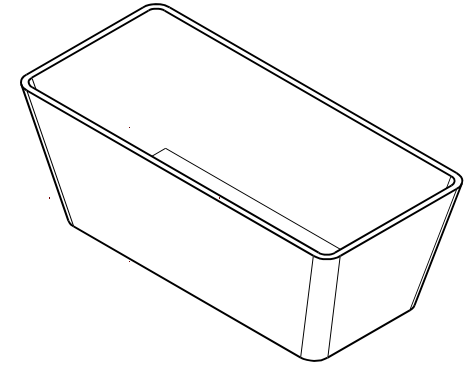

SECTION A-A

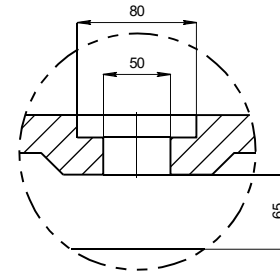







DETAIL D  
SCALE 1:4

<b>COLOUR</b>
<b>QTY</b>
<b>APPROVED BY:</b>
NAME & SIGNATURE
<b>DATE APPROVED:</b>

- NOTES
1. ALL INTERNAL CORNERS TO BE R5 UNLESS OTHERWISE STATED.
  2. AS ALL KASKADE PRODUCTS ARE HAND FINISHED A 2-5mm TOLERANCE IS ALLOWED.

COPYRIGHT © APPLIES. DUPLICATION OF THIS DRAWING OR ANY SPECIFIC DESIGN FEATURES IS NOT PERMITTED WITHOUT WRITTEN AUTHORITY. "COMMERCIAL CONFIDENTIALITY" IS ASSUMED AND REQUIRED.

UNLESS OTHERWISE STATED ALL DIMENSIONS IN MILLIMETERS		MATERIAL: KASKADE STONE	DRAWING NUMBER Amica MINI-RS5		SCALE 1:1	A4
DRAWING LEGEND		FINISH: REFER TO ORDER	Product Size 1490X680X530		SHEET 1 OF 1	REV. 1
		N.W 148 kg	Package size 1560X780X720		 www.kaskadebaths.de	
		G.W 190.5 kg	DATE 02/03/15			
		LINEAR / ANGULAR TOLERANCES	DATE 02/03/15			
		No Decimal 1 Decimal 2 Decimals	DATE			
		±5	±3°			

1	RELEASE DATE.	KASKADE	02/03/15	CHK'D	DATE
REV	DESCRIPTION	DWG	DATE	CHK'D	DATE