

DRAFT COPY

DO NOT SCALE. IF IN DOUBT ASK!

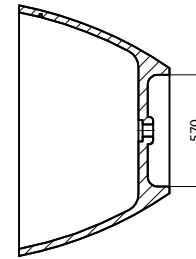

SECTION B-B

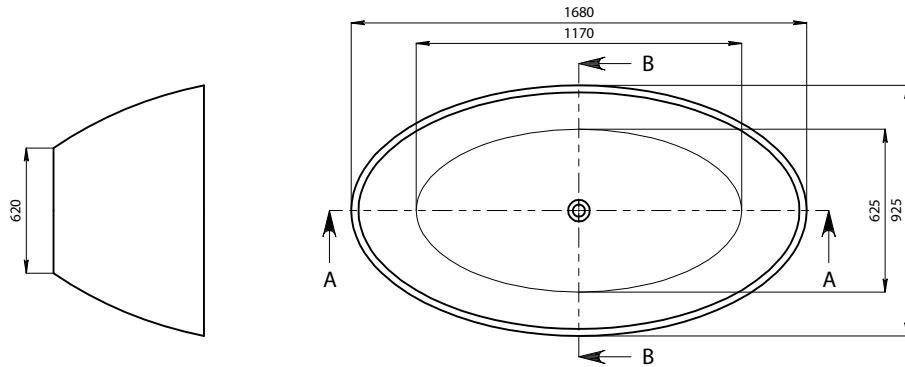
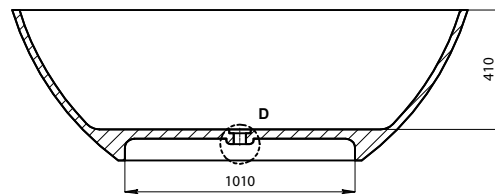
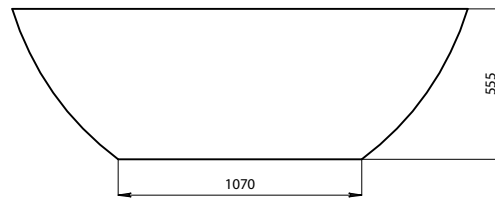
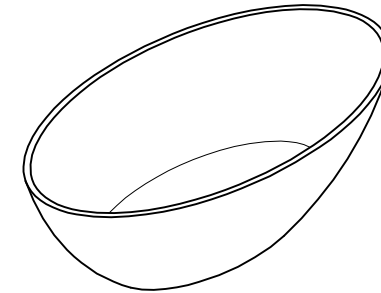

SECTION A-A

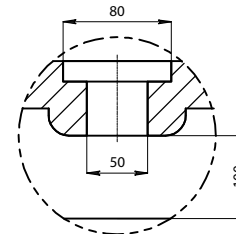

DETAIL D  
SCALE 1:4

<b>COLOUR</b>
<b>QTY</b>
<b>APPROVED BY:</b>
NAME & SIGNATURE
<b>DATE APPROVED:</b>

- NOTES
1. ALL INTERNAL CORNERS TO BE R5 UNLESS OTHERWISE STATED.
  2. AS ALL KASKADE PRODUCTS ARE HAND FINISHED A 2-5mm TOLERANCE IS ALLOWED.

COPYRIGHT © APPLIES DUPLICATION OF THIS DRAWING OR ANY SPECIFIC DESIGN FEATURES IS NOT PERMITTED WITHOUT WRITTEN AUTHORITY. "COMMERCIAL CONFIDENTIALITY" IS ASSUMED AND REQUIRED.

UNLESS OTHERWISE STATED ALL DIMENSIONS IN MILLIMETERS		MATERIAL: KASKADE STONE		DRAWING NUMBER: Plano-RS26		SCALE 1:1	A4
DRAWING LEGEND		FINISH: REFER TO ORDER		Product Size 1680X925X555		SHEET 1 OF 1	REV. 1
N.W 185 kg		G.W 238.5 kg		Package size 1780X1030X700		 <a href="http://www.kaskadebaths.de">www.kaskadebaths.de</a>	
LINEAR / ANGULAR TOLERANCES		DRAWN: KASKADE		DATE: 02/03/15			
No Decimals 1 Decimal 2 Decimals ±3°		CHK'D: DATE:		DATE:			

REV	DESCRIPTION	DWG	DATE	CHK'D	DATE
1	RELEASE DATE.	KASKADE	02/03/15		